

# CD40194B Types

## CMOS 4-Bit Bidirectional Universal Shift Register

High-Voltage Types (20 Volt Rating)

■ CD40194B is a universal shift register featuring parallel inputs, parallel outputs SHIFT RIGHT and SHIFT LEFT serial inputs, and a direct overriding clear input. In the parallel-load mode (S0 and S1 are high), data is loaded into the associated flip-flop and appears at the output after the positive transition of the CLOCK input. During loading, serial data flow is inhibited. Shift right and shift left are accomplished synchronously on the positive clock edge with data entered at the SHIFT RIGHT and SHIFT LEFT serial inputs, respectively. Clocking of the register is inhibited when both mode control inputs are low. When low, the RESET input resets all stages and forces all outputs low.

The CD40194B types are supplied in 16-lead ceramic dual-in-line packages (D and F suffixes), 16-lead dual-in-line plastic packages (E suffix), and in chip form (H suffix). The CD40194B is similar to industry types 340194 and MC40194.

**MAXIMUM RATINGS, Absolute-Maximum Values:**

<b>DC SUPPLY-VOLTAGE RANGE, (V<sub>DD</sub>)</b>	
Voltages referenced to V <sub>SS</sub> Terminal	-0.5V to +20V
<b>INPUT VOLTAGE RANGE, ALL INPUTS</b>	-0.5V to V <sub>DD</sub> +0.5V
<b>DC INPUT CURRENT, ANY ONE INPUT</b>	±10mA
<b>POWER DISSIPATION PER PACKAGE (P<sub>D</sub>):</b>	
For T <sub>A</sub> = -55°C to +100°C	500mW
For T <sub>A</sub> = +100°C to +125°C	Derate Linearity at 12mW/°C to 200mW
<b>DEVICE DISSIPATION PER OUTPUT TRANSISTOR</b>	
FOR T <sub>A</sub> = FULL PACKAGE-TEMPERATURE RANGE (All Package Types)	100mW
<b>OPERATING-TEMPERATURE RANGE (T<sub>A</sub>)</b>	-55°C to +125°C
<b>STORAGE TEMPERATURE RANGE (T<sub>stg</sub>)</b>	-65°C to +150°C
<b>LEAD TEMPERATURE (DURING SOLDERING):</b>	
At distance 1/16 ± 1/32 inch (1.59 ± 0.79mm) from case for 10s max	+265°C

**NOT RECOMMENDED FOR NEW DESIGNS**

**Features:**

- Medium-speed: f<sub>CL</sub> = 12 MHz (typ.) @ V<sub>DD</sub> = 10 V
- Fully static operation
- Synchronous parallel or serial operation
- Asynchronous master reset
- Standardized, symmetrical output characteristics
- 5-V, 10-V, and 15-V parametric ratings
- Meets all requirements of JEDEC Tentative Standard No. 13B, "Standard Specifications for Description of 'B' Series CMOS Devices"

**Applications:**

- Arithmetic unit bus registers
- Serial/parallel conversions
- General-purpose register for bus-organized systems
- General-purpose registers

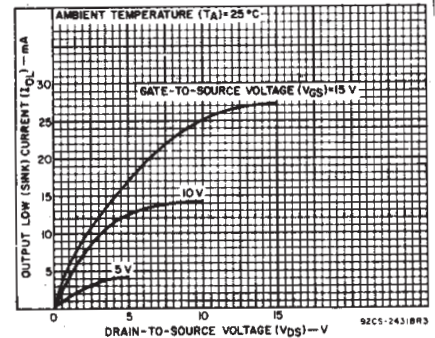
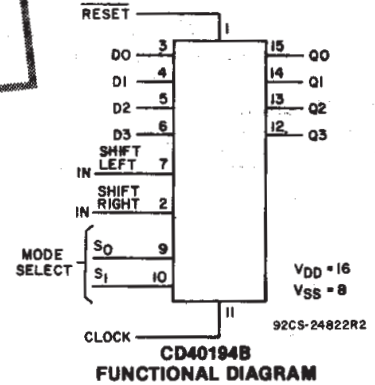

Fig. 1—Typical n-channel output low (sink) current characteristics.

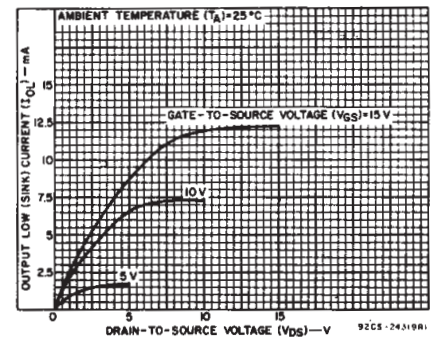

Fig. 2—Minimum n-channel output low (sink) current characteristics.



**3**  
**COMMERCIAL CMOS HIGH VOLTAGE ICs**

## CD40194B Types

**RECOMMENDED OPERATING CONDITIONS** at  $T_A = 25^\circ\text{C}$ , Except as Noted.  
**For maximum reliability, nominal operating conditions should be selected so that operation is always within the following ranges:**

CHARACTERISTIC	VDD (V)	LIMITS		UNITS
		Min.	Max.	
Supply-Voltage Range (For Package-Temperature Range)		3	18	V
Setup Time, D0, D3, SR <sub>IN</sub> , SL <sub>IN</sub> to clock	5	100	—	ns
	10	70	—	
	15	50	—	
SELECT 0, SELECT 1 to clock	5	400	—	
	10	220	—	
	15	130	—	
Hold Time, D0, D03, SR <sub>IN</sub> , SL <sub>IN</sub> to clock	5	0	—	
	10	0	—	
	15	0	—	
SELECT 0, SELECT 1 to clock	5	0	—	
	10	0	—	
	15	0	—	
Clock Pulse Width,	5	180	—	
	10	80	—	
	15	50	—	
Clock Input Frequency	5	—	3	MHz
	10	—	6	
	15	—	8	
Clock Input Rise or Fall Time,	5	1000	—	μs
	10	100	—	
	15	100	—	
Reset Pulse Width,	5	300	—	ns
	10	200	—	
	15	140	—	

### CONTROL TRUTH TABLE FOR CD40194B SERIES

CLOCK	MODE SELECT		RESET	ACTION
	S <sub>0</sub>	S <sub>1</sub>		
X	0	0	1	No Change
	1	0	1	Shift Right (Q0 toward Q3)
	0	1	1	Shift Left (Q3 toward Q0)
	1	1	1	Parallel Load
X	X	X	0	Reset

1 = High level  
 0 = Low level

X = Don't care  
 ▲ = Level change

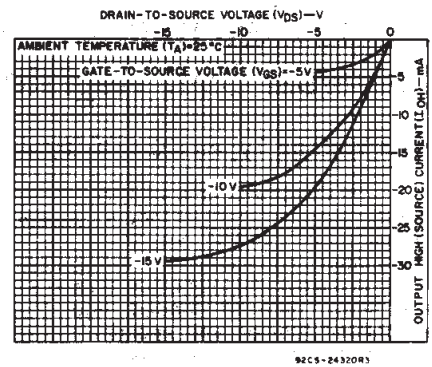

Fig. 3—Typical p-channel output high (source) current characteristics.

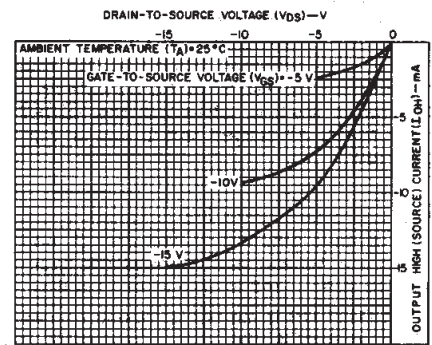

Fig. 4—Minimum p-channel output high (source) current characteristics.

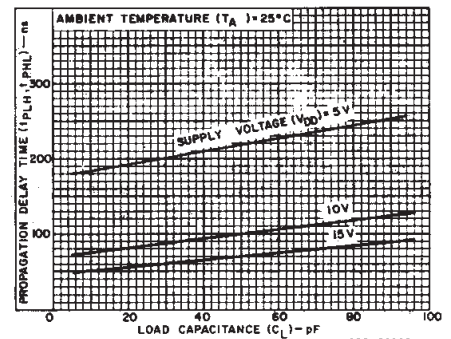

Fig. 5—Typical propagation delay time as a function of load capacitance, (CLOCK to Q).

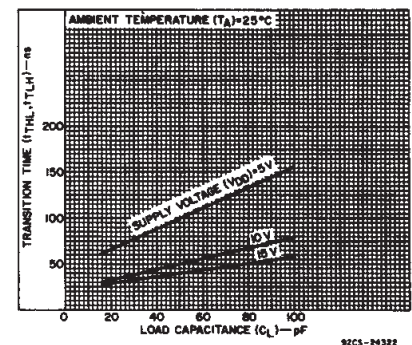

Fig. 6—Typical transition time as a function of load capacitance.

# CD40194B Types

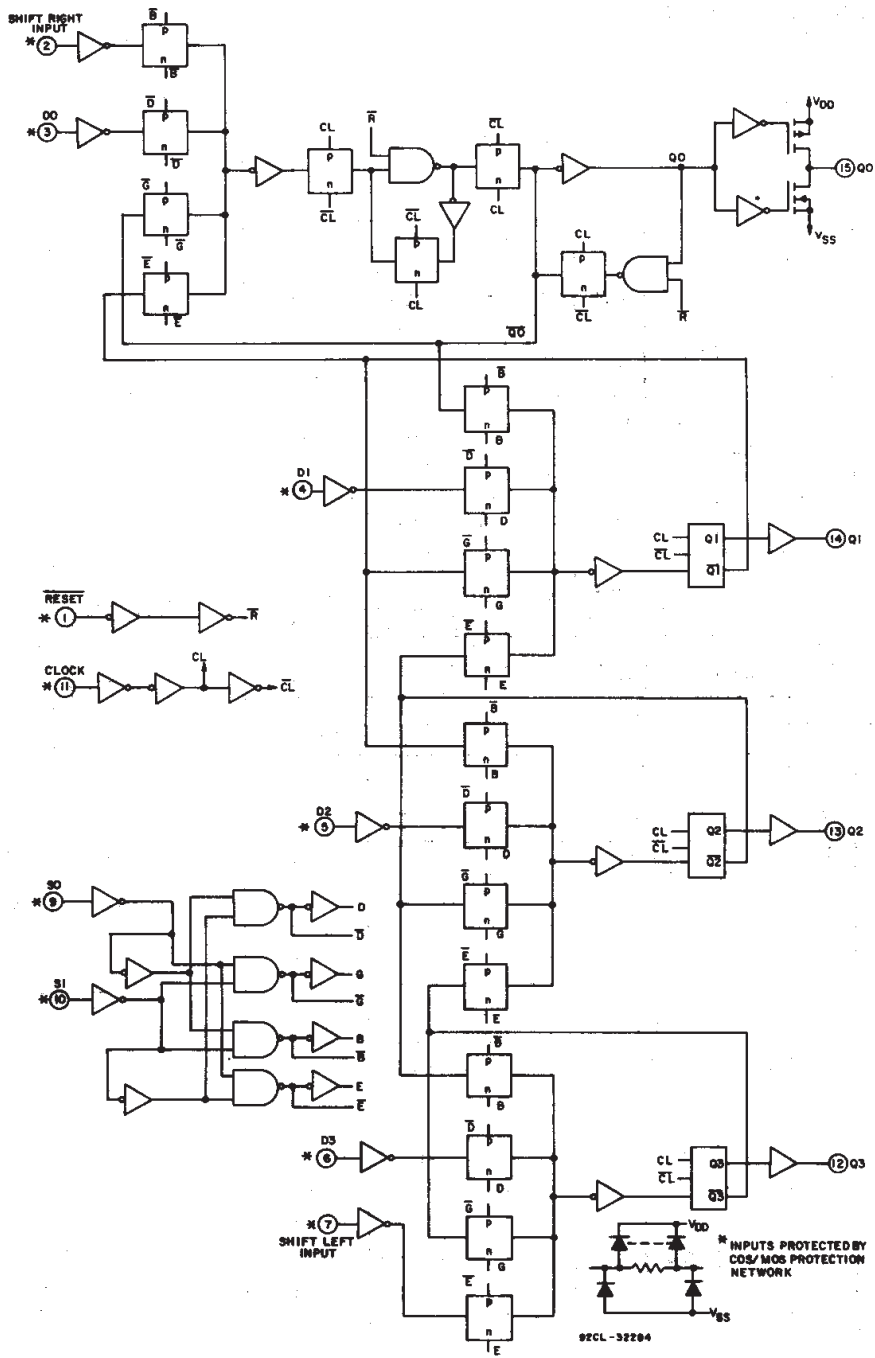

Fig. 8—CD40194B logic diagram.

COMMERCIAL CMOS  
HIGH VOLTAGE ICs

# CD40194B Types

## STATIC ELECTRICAL CHARACTERISTICS

CHARACTERISTIC	CONDITIONS			LIMITS AT INDICATED TEMPERATURES (°C)							UNITS
	V <sub>O</sub> (V)	V <sub>IN</sub> (V)	V <sub>DD</sub> (V)	-55	-40	+85	+125	Min.	Typ.	Max.	
Quiescent Device Current, I <sub>DD</sub> Max.	—	0,5	5	5	5	150	150	—	0.04	5	μA
	—	0,10	10	10	10	300	300	—	0.04	10	
	—	0,15	15	20	20	600	600	—	0.04	20	
Output Low (Sink) Current, I <sub>OL</sub> Min.	0.4	0,5	5	0.64	0.61	0.42	0.36	0.51	1	—	mA
	0.5	0,10	10	1.8	1.5	1.1	0.9	1.3	2.6	—	
	1.5	0,15	15	4.2	4	2.8	2.4	3.4	6.8	—	
Output High (Source) Current, I <sub>OH</sub> Min.	4.6	0,5	5	-0.64	-0.61	-0.42	-0.36	-0.51	-1	—	mA
	2.5	0,5	5	-2	-1.8	-1.3	-1.15	-1.6	-3.2	—	
	9.5	0,10	10	-1.6	-1.5	-1.1	-0.9	-1.3	-2.6	—	
Output Voltage: Low-Level, V <sub>OL</sub> Max.	—	0,5	5	0.05				—	0	0.05	V
	—	0,10	10	0.05				—	0	0.05	
	—	0,15	15	0.05				—	0	0.05	
Output Voltage: High-Level, V <sub>OH</sub> Min.	—	0,5	5	4.95				4.95	5	—	V
	—	0,10	10	9.95				9.95	10	—	
	—	0,15	15	14.95				14.95	15	—	
Input Low Voltage, V <sub>IL</sub> Max.	0.5,4.5	—	5	1.5				—	—	1.5	V
	1,9	—	10	3				—	—	3	
	1.5,13.5	—	15	4				—	—	4	
Input High Voltage, V <sub>IH</sub> Min.	0.5,4.5	—	5	3.5				3.5	—	—	V
	1,9	—	10	7				7	—	—	
	1.5,13.5	—	15	11				11	—	—	
Input Current I <sub>IN</sub> Max.	—	0,18	18	±0.1	±0.1	±1	±1	—	±10 <sup>-5</sup>	±0.1	μA
3-State Output Leakage Current, I <sub>OUT</sub> Max.	0,18	0,18	18	±0.4	±0.4	±12	±12	—	±10 <sup>-4</sup>	±0.4	μA

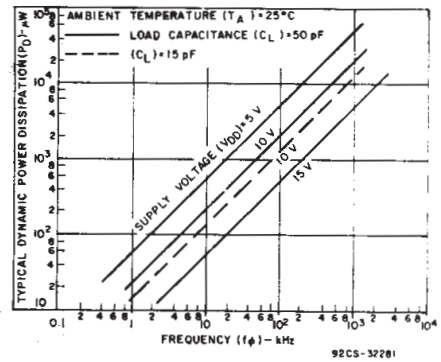

Fig. 9—Typical power dissipation as a function of frequency.

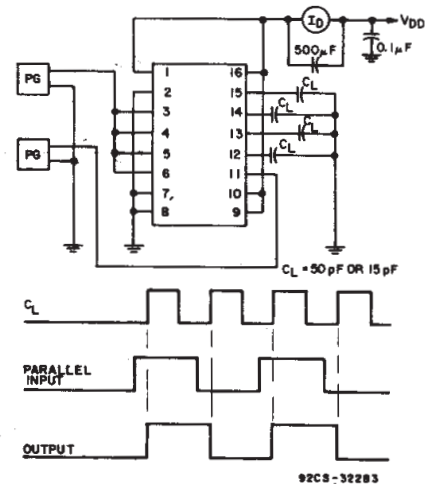

Fig. 10—Dynamic power dissipation test circuit.

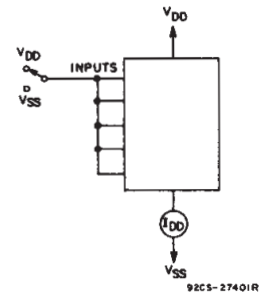

Fig. 11—Quiescent device current test circuit.

# CD40194B Types

DYNAMIC ELECTRICAL CHARACTERISTICS at  $T_A = 25^\circ\text{C}$ ,  
 Input  $t_r, t_f = 20 \text{ ns}$ ,  $C_L = 50 \text{ pF}$ ,  $R_L = 200 \text{ k}\Omega$

CHARACTERISTIC	TEST CONDITIONS	LIMITS			UNITS		
		VDD V	Min.	Typ.		Max.	
Propagation Delay Time: Clock to Q $t_{PHL}, t_{PLH}$		5	—	220	440	ns	
		10	—	100	200		
		15	—	70	140		
Output Transition Time $t_{THL}, t_{TLH}$		5	—	100	200		
		10	—	50	100		
		15	—	40	80		
Minimum Setup Time: $t_s$ D0, D3, SR <sub>IN</sub> , SL <sub>IN</sub> to Clock		5	—	80	160		
		10	—	35	70		
		15	—	20	50		
SELECT 0, SELECT 1 to Clock		5	—	200	400		
		10	—	110	220		
		15	—	65	130		
Minimum Hold Time: $t_H$ D0, D3, SR <sub>IN</sub> , SL <sub>IN</sub> to Clock		5	—	-65	0		
		10	—	-25	0		
		15	—	-15	0		
SELECT 0, SELECT 1 to Clock		5	—	-170	0		
		10	—	-95	0		
		15	—	-55	0		
Minimum Clock Pulse Width $t_W$		5	—	90	180		
		10	—	40	80		
		15	—	25	50		
Maximum Clock Input Frequency $f_{CL}$		5	3	6	—	MHz	
		10	6	12	—		
		15	8	15	—		
Maximum Clock Rise or Fall Time $t_{rCL}, t_{fCL}$		5	—	—	1000	$\mu\text{s}$	
		10	—	—	100		
		15	—	—	100		
Minimum Reset Pulse Width* $t_{WR}$		5	—	150	300	ns	
		10	—	100	200		
		15	—	70	140		
Reset Propagation Delay $t_{PRHL}$		5	—	230	460		
		10	—	90	180		
		15	—	65	130		
Input Capacitance $C_{IN}$	Any Input		—	5	7.5		pF

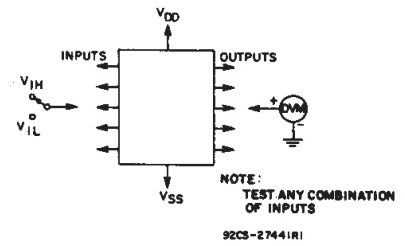

Fig. 12—Input-voltage test circuit.

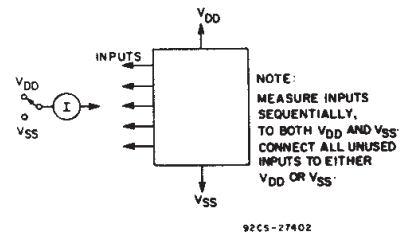
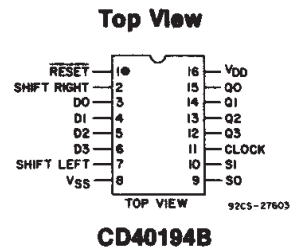

Fig. 13—Input current test circuit.

## TERMINAL DIAGRAM



3  
COMMERCIAL CMOS  
HIGH VOLTAGE ICs

## CD40194B Types

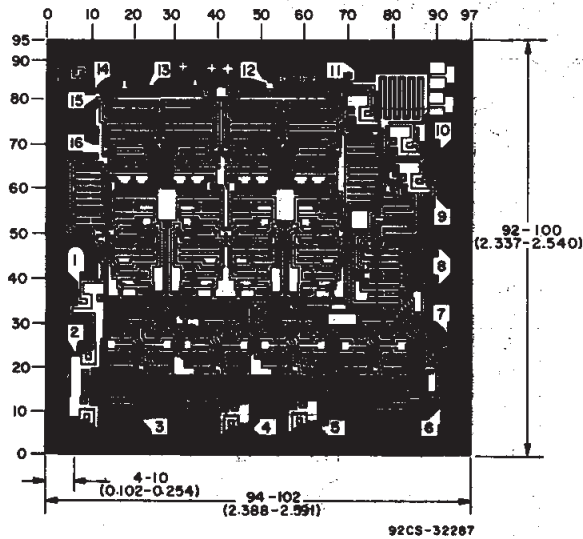

*Dimensions and pad layout for CD40194BH*

*Dimensions in parentheses are in millimeters and are derived from the basic inch dimensions as indicated. Grid graduations are in mils ( $10^{-3}$  inch).*

## IMPORTANT NOTICE

Texas Instruments and its subsidiaries (TI) reserve the right to make changes to their products or to discontinue any product or service without notice, and advise customers to obtain the latest version of relevant information to verify, before placing orders, that information being relied on is current and complete. All products are sold subject to the terms and conditions of sale supplied at the time of order acknowledgement, including those pertaining to warranty, patent infringement, and limitation of liability.

TI warrants performance of its semiconductor products to the specifications applicable at the time of sale in accordance with TI's standard warranty. Testing and other quality control techniques are utilized to the extent TI deems necessary to support this warranty. Specific testing of all parameters of each device is not necessarily performed, except those mandated by government requirements.

CERTAIN APPLICATIONS USING SEMICONDUCTOR PRODUCTS MAY INVOLVE POTENTIAL RISKS OF DEATH, PERSONAL INJURY, OR SEVERE PROPERTY OR ENVIRONMENTAL DAMAGE ("CRITICAL APPLICATIONS"). TI SEMICONDUCTOR PRODUCTS ARE NOT DESIGNED, AUTHORIZED, OR WARRANTED TO BE SUITABLE FOR USE IN LIFE-SUPPORT DEVICES OR SYSTEMS OR OTHER CRITICAL APPLICATIONS. INCLUSION OF TI PRODUCTS IN SUCH APPLICATIONS IS UNDERSTOOD TO BE FULLY AT THE CUSTOMER'S RISK.

In order to minimize risks associated with the customer's applications, adequate design and operating safeguards must be provided by the customer to minimize inherent or procedural hazards.

TI assumes no liability for applications assistance or customer product design. TI does not warrant or represent that any license, either express or implied, is granted under any patent right, copyright, mask work right, or other intellectual property right of TI covering or relating to any combination, machine, or process in which such semiconductor products or services might be or are used. TI's publication of information regarding any third party's products or services does not constitute TI's approval, warranty or endorsement thereof.